

REVISION HISTORY			
Rev	DESCRIPTION	DATE	APPROVED

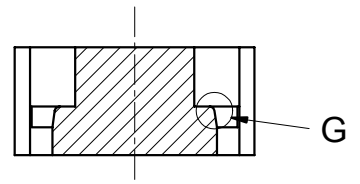

Section E-E

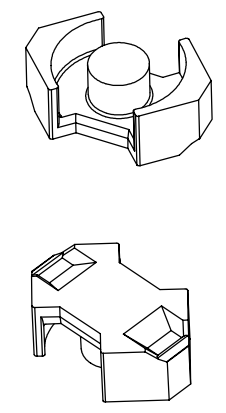
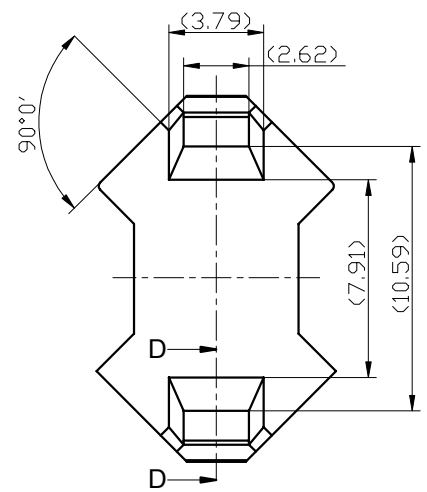
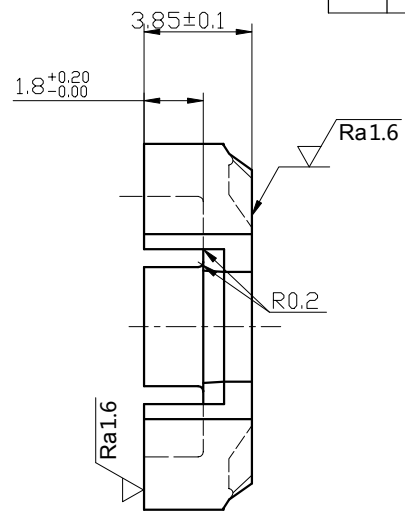
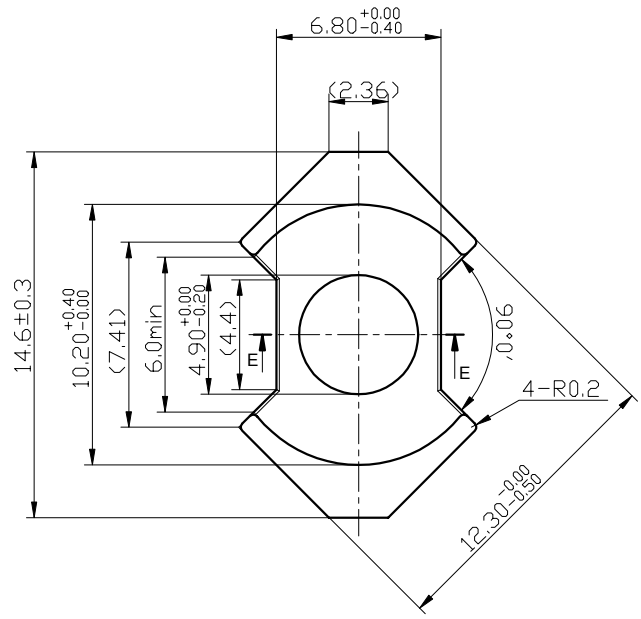
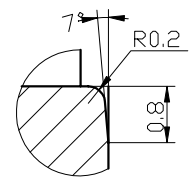

Detail G

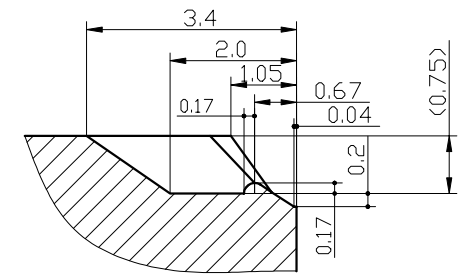

Section D-D

	Scale	Material	Customer Part number	
	4: 1			
Unit:	Standard tolerances	Product Name		
mm	±0.1	RM-5S-7.8		
Approved by	Created by	Document type	Rev	Drawing No.
Y.Higuchi	H.Huang	Production drawing	00	PY170707M09
Hitachi Metals (Hong kong) Ltd. Panyu Factory			Date of issue	Sheet
			Jul 07 2017	1/1